

DATA SHEET

BLW83 HF/VHF power transistor

Product specification

August 1986

HF/VHF power transistor

BLW83

DESCRIPTION

N-P-N silicon planar epitaxial transistor for use in transmitting amplifiers operating in the h.f. and v.h.f. bands, with a nominal supply voltage of 28 V. The transistor is specified for s.s.b. applications as linear amplifier in class-A and AB. The device is resistance stabilized and is guaranteed to withstand severe load mismatch conditions.

Matched h_{FE} groups are available on request.

It has a 3/8" flange envelope with a ceramic cap. All leads are isolated from the flange.

QUICK REFERENCE DATA

R.F. performance

MODE OF OPERATION	V_{CE} V	f MHz	P_L W	G_p dB	η_{dt} %	I_C A	d_3 dB	T_h °C
s.s.b. (class-A)	26	1,6 – 28	0 – 10 (P.E.P.)	> 20	–	1,35	< –40	70
s.s.b. (class-AB)	28	1,6 – 28	3 – 30 (P.E.P.)	typ. 21	typ. 40	typ. 1,34	typ. –30	25

PIN CONFIGURATION

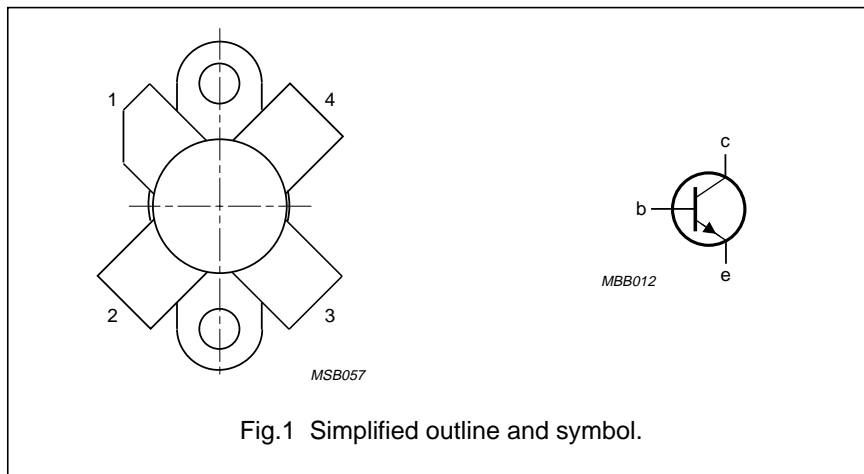

PINNING - SOT123

PIN	DESCRIPTION
1	collector
2	emitter
3	base
4	emitter

PRODUCT SAFETY This device incorporates beryllium oxide, the dust of which is toxic. The device is entirely safe provided that the BeO disc is not damaged.

HF/VHF power transistor

BLW83

RATINGS

Limiting values in accordance with the Absolute Maximum System (IEC 134)

Collector-emitter voltage ($V_{BE} = 0$)

peak value

V_{CESM} max. 65 V

Collector-emitter voltage (open base)

V_{CEO} max. 36 V

Emitter-base voltage (open-collector)

V_{EBO} max. 4 V

Collector current (average)

$I_{C(AV)}$ max. 3 A

Collector current (peak value); $f > 1$ MHz

I_{CM} max. 9 A

R.F. power dissipation ($f > 1$ MHz); $T_{mb} = 25$ °C

P_{rf} max. 76 W

Storage temperature

T_{stg} -65 to + 150 °C

Operating junction temperature

T_j max. 200 °C

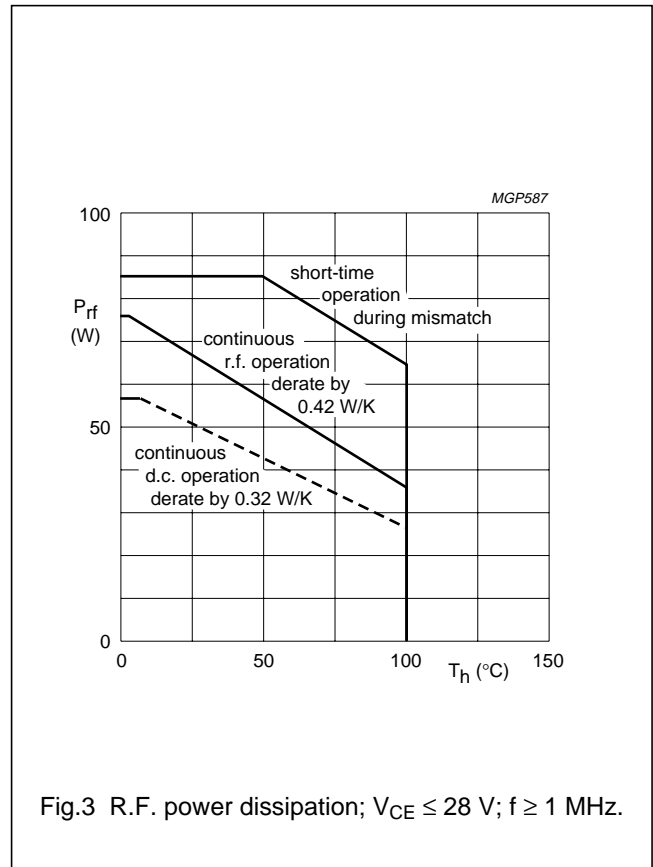
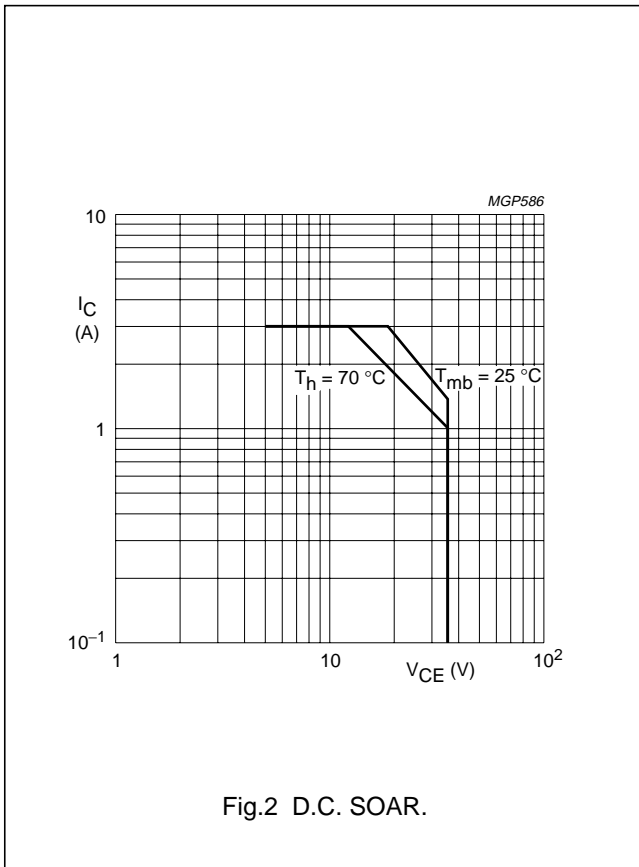

THERMAL RESISTANCE

(dissipation = 35 W; $T_{mb} = 80$ °C, i.e. $T_h = 70$ °C)

From junction to mounting base (d.c. dissipation)

$R_{th\ j-mb(dc)}$ = 3,15 K/W

From junction to mounting base (r.f. dissipation)

$R_{th\ j-mb(rf)}$ = 2,35 K/W

From mounting base to heatsink

$R_{th\ mb-h}$ = 0,3 K/W

HF/VHF power transistor

BLW83

CHARACTERISTICS

$T_j = 25\text{ }^\circ\text{C}$ unless otherwise specified

Collector-emitter breakdown voltage $V_{BE} = 0; I_C = 10\text{ mA}$	$V_{(BR)CES}$	>	65 V
Collector-emitter breakdown voltage open base; $I_C = 50\text{ mA}$	$V_{(BR)CEO}$	>	36 V
Emitter-base breakdown voltage open collector; $I_E = 10\text{ mA}$	$V_{(BR)EBO}$	>	4 V
Collector cut-off current $V_{BE} = 0; V_{CE} = 36\text{ V}$	I_{CES}	<	4 mA
Second breakdown energy; $L = 25\text{ mH}; f = 50\text{ Hz}$ open base	E_{SBO}	>	8 mJ
$R_{BE} = 10\text{ }\Omega$	E_{SBR}	>	8 mJ
D.C. current gain ⁽¹⁾ $I_C = 1,25\text{ A}; V_{CE} = 5\text{ V}$	h_{FE}	typ.	50 10 to 100
D.C. current gain ratio of matched devices ⁽¹⁾ $I_C = 1,25\text{ A}; V_{CE} = 5\text{ V}$	h_{FE1}/h_{FE2}	<	1,2
Collector-emitter saturation voltage ⁽¹⁾ $I_C = 3,75\text{ A}; I_B = 0,75\text{ A}$	V_{CEsat}	typ.	1,5 V
Transition frequency at $f = 100\text{ MHz}$ ⁽¹⁾ $-I_E = 1,25\text{ A}; V_{CB} = 28\text{ V}$	f_T	typ.	530 MHz
$-I_E = 3,75\text{ A}; V_{CB} = 28\text{ V}$	f_T	typ.	530 MHz
Collector capacitance at $f = 1\text{ MHz}$ $I_E = I_e = 0; V_{CB} = 28\text{ V}$	C_c	typ.	50 pF
Feedback capacitance at $f = 1\text{ MHz}$ $I_C = 100\text{ mA}; V_{CE} = 28\text{ V}$	C_{re}	typ.	31 pF
Collector-flange capacitance	C_{cf}	typ.	2 pF

Note

1. Measured under pulse conditions: $t_p \leq 200\text{ }\mu\text{s}; \delta \leq 0,02$.

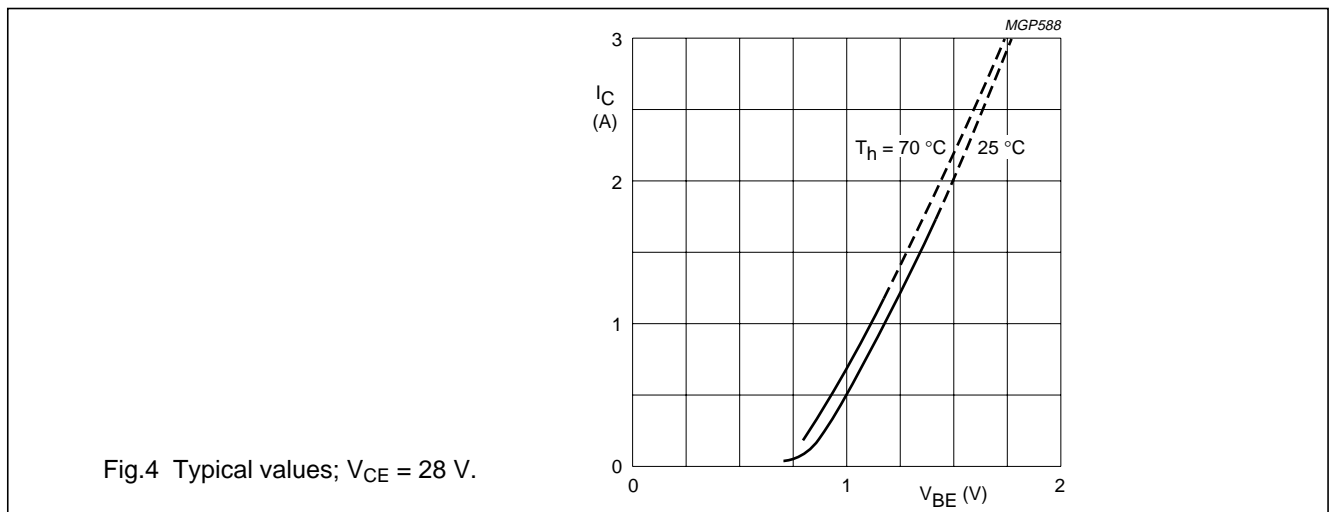

HF/VHF power transistor

BLW83

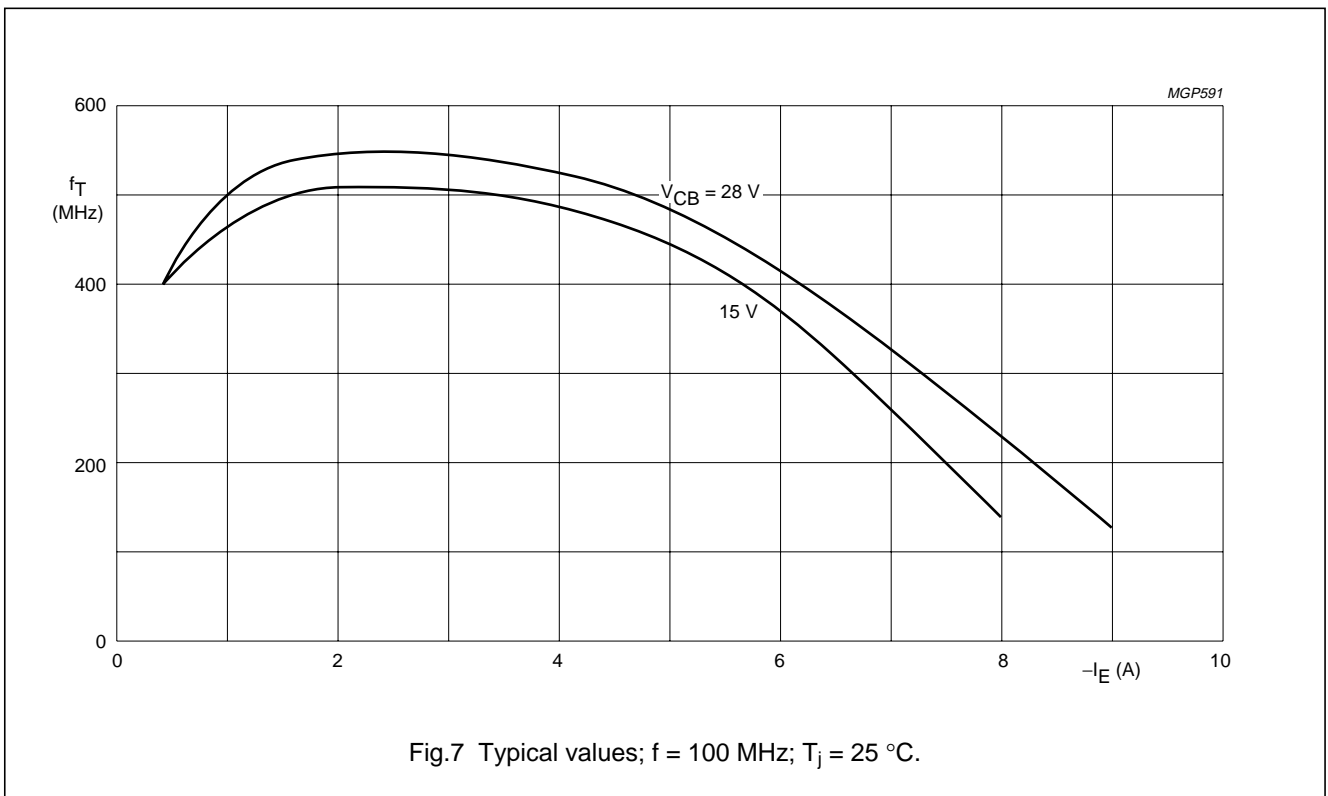
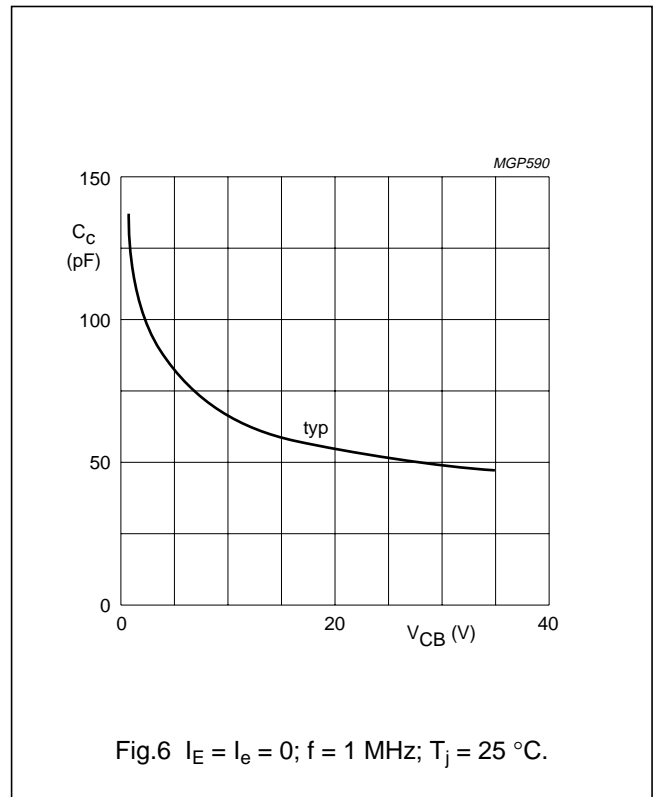
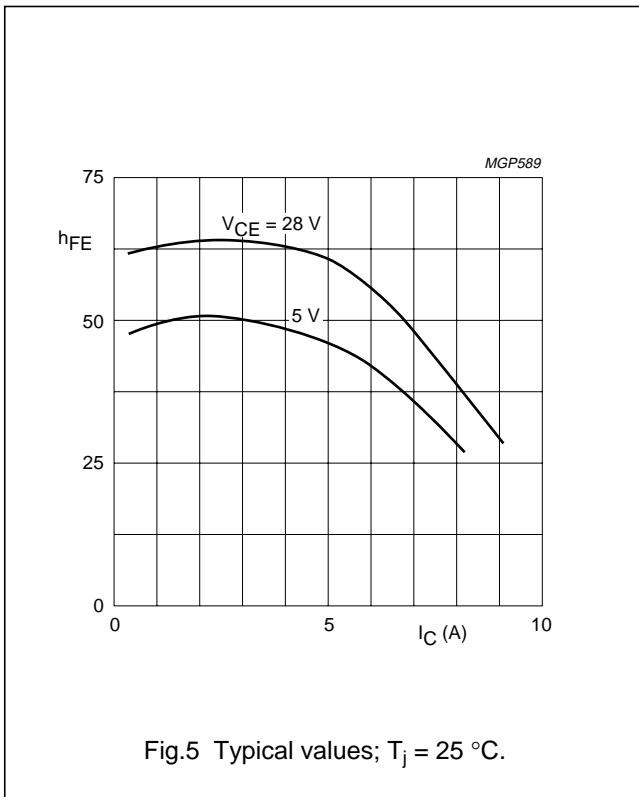

HF/VHF power transistor

BLW83

APPLICATION INFORMATION

R.F. performance in s.s.b. class-A operation (linear power amplifier)

$V_{CE} = 26 \text{ V}$; $f_1 = 28,000 \text{ MHz}$; $f_2 = 28,001 \text{ MHz}$

OUTPUT POWER W	G_p dB	I_c A	d_3 dB ⁽¹⁾	d_5 dB ⁽¹⁾	T_h °C
> 10 (P.E.P.)	> 20	1,35	-40	< -40	70
typ. 11 (P.E.P.)					
typ. 12 (P.E.P.)	typ. 24	1,35	-40	< -40	25

Note

1. Stated intermodulation distortion figures are referred to the according level of either of the equal amplified tones. Relative to the according peak envelope powers these figures should be increased by 6 dB.

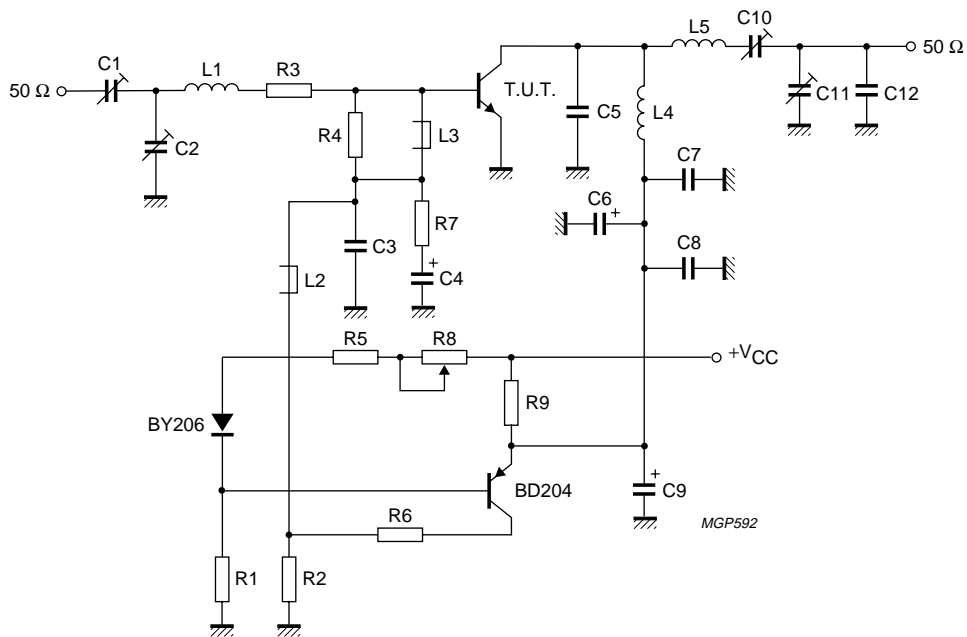

Fig.8 Test circuit; s.s.b. class-A.

HF/VHF power transistor

BLW83

List of components in Fig.8:

- C1 = C2 = 10 to 780 pF film dielectric trimmer
- C3 = 22 nF ceramic capacitor (63 V)
- C4 = 47 μ F/10 V electrolytic capacitor
- C5 = 56 pF ceramic capacitor (500 V)
- C6 = 47 μ F/35 V electrolytic capacitor
- C7 = C8 = 220 nF polyester capacitor
- C9 = 10 μ F/35 V electrolytic capacitor
- C10 = C11 = 7 to 100 pF film dielectric trimmer
- C12 = 82 pF ceramic capacitor (500 V)
- L1 = 3 turns closely wound enamelled Cu wire (1,6 mm); int. dia. 9,0 mm; leads to 2 \times 5 mm
- L2 = L3 = Ferroxcube wide-band h.f. choke, grade 3B (cat. no. 4312 020 36640)
- L4 = 11 turns closely wound enamelled Cu wire (1,6 mm); int. dia. 11,0 mm
- L5 = 14 turns closely wound enamelled Cu wire (1,6 mm); int. dia. 11,0 mm
- R1 = 600 Ω ; parallel connection of 2 \times 1,2 k Ω carbon resistors (\pm 5%; 0,5 W each)
- R2 = 15 Ω carbon resistor (\pm 5%; 0,25 W)
- R3 = 1,2 Ω ; parallel connection of 4 \times 4,7 Ω carbon resistors (\pm 5%; 0,125 W each)
- R4 = 33 Ω carbon resistor (\pm 5%; 0,25 W)
- R5 = 18 Ω carbon resistor (\pm 5%; 0,25 W)
- R6 = 120 Ω wirewound resistor (\pm 5%; 5,5 W)
- R7 = 1 Ω carbon resistor (\pm 5%; 0,125 W)
- R8 = 47 Ω wirewound potentiometer (3 W)
- R9 = 1,57 Ω ; parallel connection of 3 \times 4,7 Ω wirewound resistors (5%; 5,5 W each)

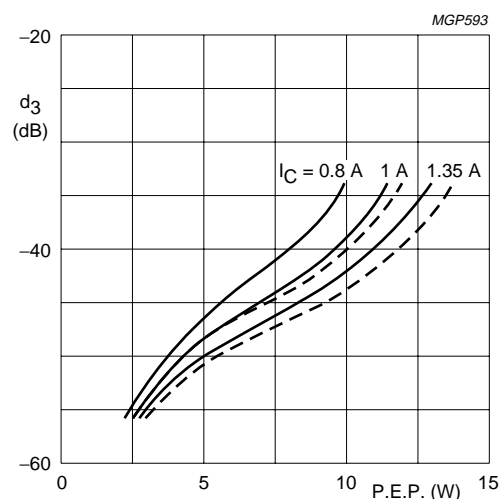

Fig.9 Intermodulation distortion as a function of output power.
 Typical values; $V_{CE} = 26$ V; — $T_h = 70$ °C; - - - $T_h = 25$ °C.

HF/VHF power transistor

BLW83

R.F. performance in s.s.b. class-AB operation (linear power amplifier)

 $V_{CE} = 28 \text{ V}$; $f_1 = 28,000 \text{ MHz}$; $f_2 = 28,001 \text{ MHz}$

OUTPUT POWER W	G_p dB	η_{dt} (%) at 30 W P.E.P.	I_c (A)	d_3 dB ⁽¹⁾	d_5 dB ⁽¹⁾	$I_{c(zs)}$ mA	T_h °C
3 to 30 (P.E.P.)	typ. 21	typ. 40	typ. 1,34	typ. -30	< -30	25	25
3 to 25 (P.E.P.)	typ. 21	-	-	typ. -30	< -30	25	70

Note

1. Stated intermodulation distortion figures are referred to the according level of either of the equal amplified tones. Relative to the according peak envelope powers these figures should be increased by 6 dB.

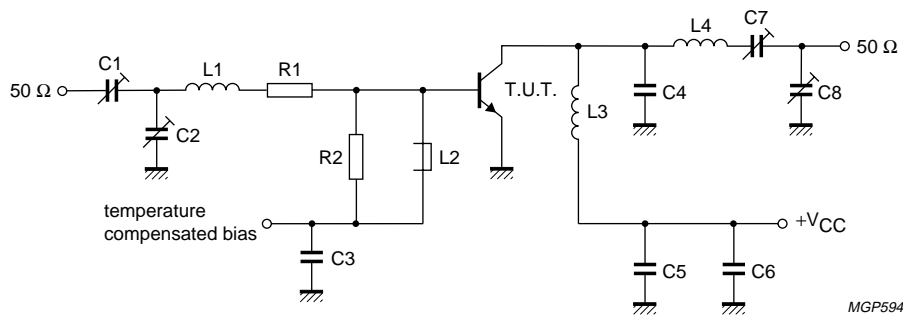

Fig.10 Test circuit; s.s.b. class-AB.

List of components:

- C1 = C2 = 10 to 780 pF film dielectric trimmer
- C3 = C5 = C6 = 220 nF polyester capacitor
- C4 = 56 pF ceramic capacitor (500 V)
- C7 = C8 = 15 to 575 pF film dielectric trimmer
- L1 = 4 turns closely wound enamelled Cu wire (1,6 mm); int. dia. 7,0 mm; leads 2 × 5 mm
- L2 = Ferroxcube wide-band h.f. choke, grade 3B (cat. no. 4312 020 36640)
- L3 = 4 turns enamelled Cu wire (1,6 mm); int. dia. 10 mm; length 9,4 mm; leads 2 × 5 mm
- L4 = 7 turns enamelled Cu wire (1,6 mm); int. dia. 12 mm; length 17,2 mm; leads 2 × 5 mm
- R1 = 1,2 Ω; parallel connection of 4 × 4,7 Ω carbon resistors
- R2 = 39 Ω carbon resistor

HF/VHF power transistor

BLW83

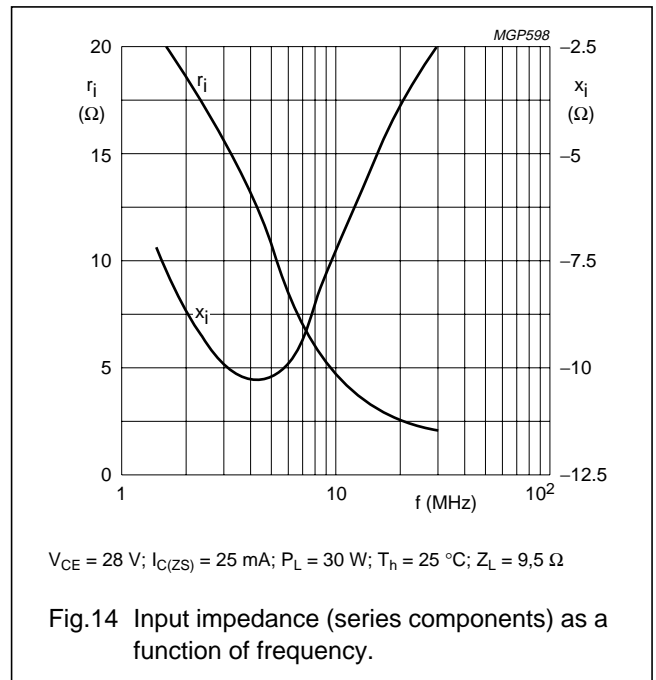
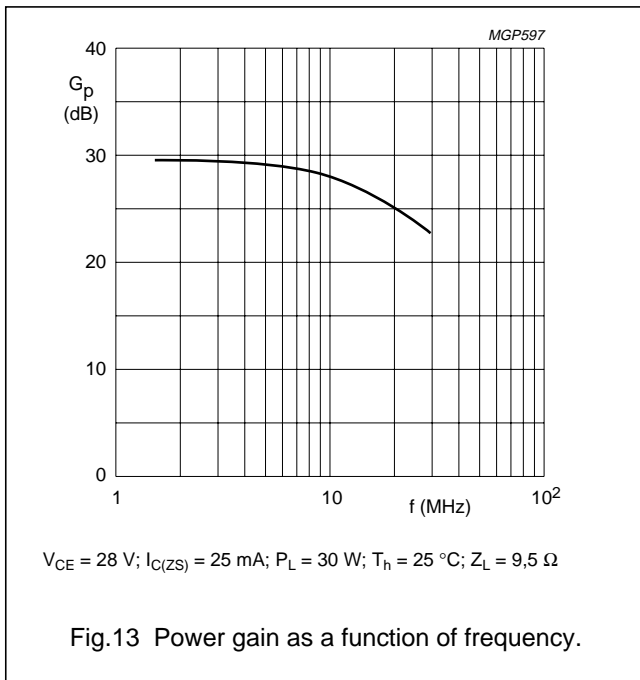
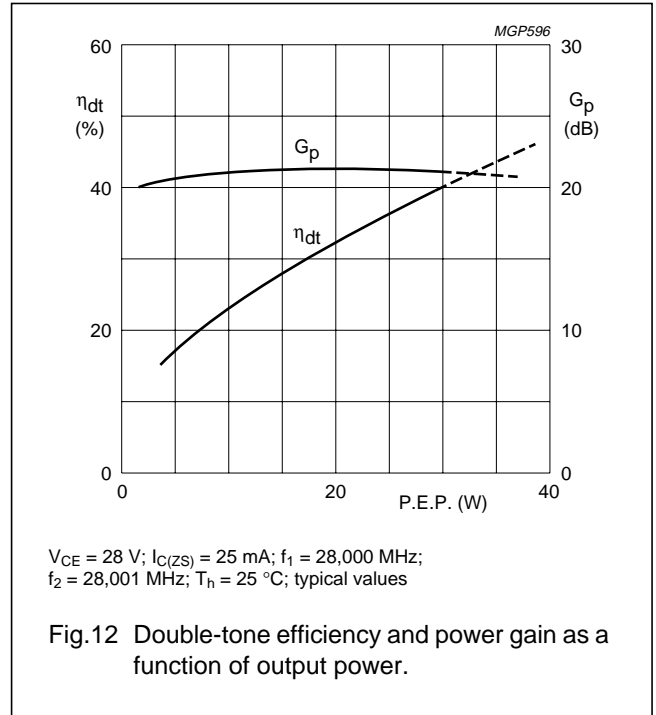
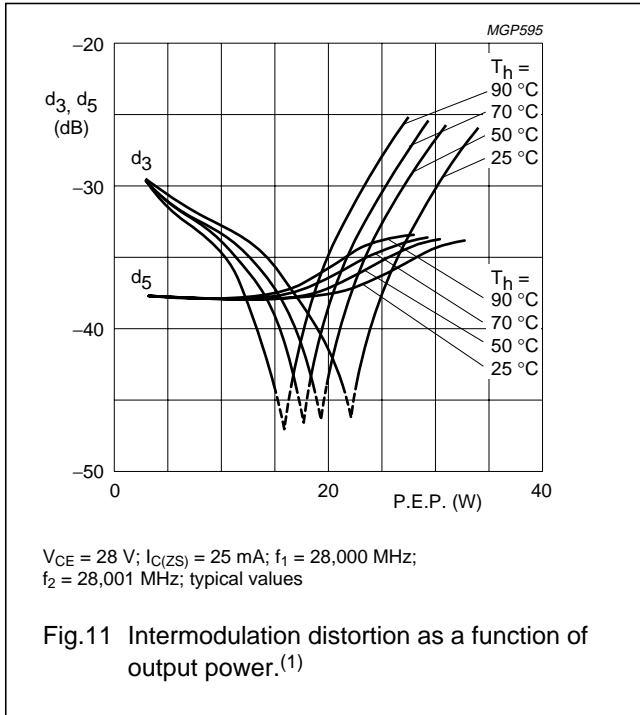

Figs 13 and 14 are typical curves and hold for an unneutralized amplifier in s.s.b. class-AB operation.

Ruggedness in s.s.b. operation

The BLW83 is capable of withstanding a load mismatch (VSWR = 50) under the following conditions: $f_1 = 28,000 \text{ MHz}; f_2 = 28,001 \text{ MHz}; V_{CE} = 28 \text{ V}; T_h = 70 \text{ °C}$ and $P_{Lnom} = 35 \text{ W (P.E.P.)}$.

HF/VHF power transistor

BLW83

PACKAGE OUTLINE

Flanged ceramic package; 2 mounting holes; 4 leads

SOT123A

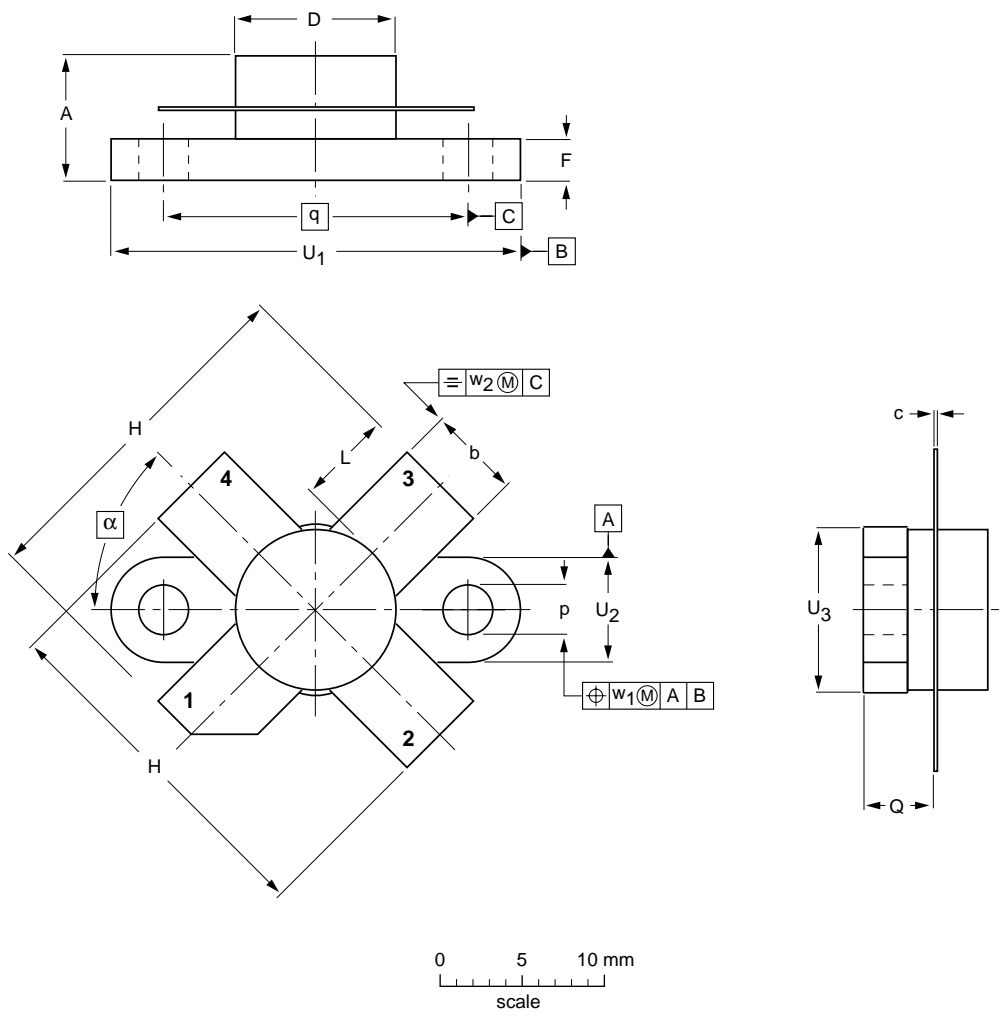

DIMENSIONS (millimetre dimensions are derived from the original inch dimensions)

UNIT	A	b	c	D	D ₁	F	H	L	p	Q	q	U ₁	U ₂	U ₃	w ₁	w ₂	α
mm	7.47 6.37	5.82 5.56	0.18 0.10	9.73 9.47	9.63 9.42	2.72 2.31	20.71 19.93	5.61 5.16	3.33 3.04	4.63 4.11	18.42	25.15 24.38	6.61 6.09	9.78 9.39	0.51	1.02	45°
inches	0.294 0.251	0.229 0.219	0.007 0.004	0.383 0.373	0.397 0.371	0.107 0.091	0.815 0.785	0.221 0.203	0.131 0.120	0.182 0.162	0.725	0.99 0.96	0.26 0.24	0.385 0.370	0.02	0.04	

OUTLINE VERSION	REFERENCES				EUROPEAN PROJECTION	ISSUE DATE
	IEC	JEDEC	EIAJ			
SOT123A						97-06-28

HF/VHF power transistor

BLW83

DEFINITIONS

Data Sheet Status	
Objective specification	This data sheet contains target or goal specifications for product development.
Preliminary specification	This data sheet contains preliminary data; supplementary data may be published later.
Product specification	This data sheet contains final product specifications.
Limiting values	
Limiting values given are in accordance with the Absolute Maximum Rating System (IEC 134). Stress above one or more of the limiting values may cause permanent damage to the device. These are stress ratings only and operation of the device at these or at any other conditions above those given in the Characteristics sections of the specification is not implied. Exposure to limiting values for extended periods may affect device reliability.	
Application information	
Where application information is given, it is advisory and does not form part of the specification.	

LIFE SUPPORT APPLICATIONS

These products are not designed for use in life support appliances, devices, or systems where malfunction of these products can reasonably be expected to result in personal injury. Philips customers using or selling these products for use in such applications do so at their own risk and agree to fully indemnify Philips for any damages resulting from such improper use or sale.